

Performance Data

Dimensions

Please Contact Yanmar for Details

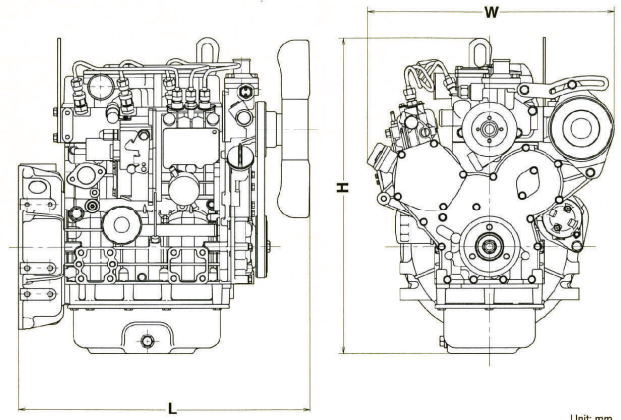

Unit: mm

Length	30.0 in (763 mm)
Width	20.9 in (532 mm)
Height	29.1 in (740 mm)

Note: Dimensions depend on final specifications.

kW to Hp conversion used is expressed as: $HP = (kW \text{ value}) \times 1.34$

Rated Speed (rpm)	Net rated kW	Net rated HP	Max. Torque (ft-lb)
1800	40.8	54.7	Call Yanmar

Ratings Definitions and Conditions

*Rated power listed is NET engine output. The engine operating environment and driven machine conditions must be studied carefully when selecting an engine in order to ensure correct engine selection, maximize engine performance, extend engine service life and improve machine capacity.

Consult the TNV Application Manual for additional engine ratings and engine application information.

Application standards for Yanmar industrial engines: Inlet air standard conditions with a total barometric pressure of 100kPa (29.5 in. Hg), with a vapor pressure of 1 kPa (.295 in. Hg), and 25°C (77°F).

Materials and specifications herein are intended to serve as a guide in engine selection and subject to change without notice. The International System of Units (SI) is used in this publication. Yanmar and its logos, as well as corporate identity used herein, are trademarks of Yanmar and may not be used without permission.